

*Ask Orange™*

Provides solutions  
to process problems



How To

# Choose & Use Vibratory Feeders & Conveyors

Complete guide to  
Vibratory Feeders and Conveyors



World authority in advanced  
technology for magnetic, vibratory  
and metal detection applications.

**It's not magic...it's ERIEZ**

## HOW TO CHOOSE AND USE VIBRATORY FEEDERS & CONVEYORS

Introduction	3
Defining Equipment Terms	3
Conveying & Feeding	3
How Vibratory Equipment Works	4
The Vibratory Movement	4
Single-Mass Designs & Two-Mass Designs	5
Equipment Components	6
Drive Systems	6
Electromagnetic Drives	6
Mechanical Drives	7
Spring Systems	7
Tray or Trough Designs	8
Material and Process Considerations	9
Material Considerations	9
Process Considerations	10
Vibratory Equipment	11
Feeders, Electromagnetic	11
Feeders, Mechanical	12
Conveyors	12
Custom Equipment & Applications	14



***Ask Orange™ is a collection of process solution case studies and how-to reference manuals designed to improve understanding and simplify specifying sophisticated magnetic, vibratory and metal detection equipment needed in most process industries. Most of this equipment requires an understanding of its intended use in order to determine proper application.***

*The "Professor" icon has been developed to help customers identify Ask Orange™ material in printed trade publications, company literature and on its web site. The Ask Orange concept and related images are a tribute to the company's founder, Orange F. Merwin, and his innovative ideas using magnets to remove metal contamination from various process flows.*

# HOW TO CHOOSE AND USE VIBRATORY FEEDERS & CONVEYORS

The need to move, convey and feed product exists in virtually all industries. Whether a sophisticated food processing plant or a simple packaging line, product needs to move from one area to the next. This book, *How to Choose and Use Vibratory Feeders and Conveyors* will focus on selecting vibratory equipment to move raw and unfinished goods in process applications... meaning, it will not discuss belt conveyors, forklift trucks, gravity flow storage systems or pick and pack modules moving finished goods. It is written to help users select the correct vibratory feeder, conveyor or screener for their particular process or packaging applications. Always read manufacturers' operating manuals and safety information prior to equipment operation.

## DEFINING EQUIPMENT TERMS

### Conveying and Feeding

All of Eriez' vibratory equipment is designed to simply convey, feed or screen product. Conveyors and feeders are often used in concert to efficiently move product in and through a process plant.

In broadest terms, to convey is "to take or carry from one place to another; to transport". Typically, conveyors are used to move product from one point to another point in a process. For example, conveyors might be used to move raw materials from a rail car to a storage tank, and then again to move that material from the storage tank into the plant or process. In most process applications, material must be conveyed repeatedly throughout the plant. In many instances, that product must first be fed onto the conveyor. Feeders provide more precise "metering" of product.

Feeding by definition, means, "to supply or maintain a flow of material." Feeders are placed throughout a plant to maintain the flow of product coming into the next stage of the process. In the example above, the product leaving the storage tank will likely be fed on to the conveyor going into the process. A heavy-duty feeder attached to the bottom of the storage tank will meter-out the proper amount of material to flow into the process. Feeders often control the flow of the process and are typically required to turn off and on frequently, based on demand.



### The Vibratory Movement

Vibrating, again by definition, means “to move back and forth rapidly.” The equipment and process solutions described in this guide all use this rapid “back and forth” motion to move or convey product. On a vibratory feeder, material is “thrown” up and forward so that it drops to the surface at a point further down the tray. This is the feeder’s amplitude. The number of times per minute that this repeats is the frequency. A third variable is the angle of deflection... meaning how high the product is thrown as compared to its horizontal movement.

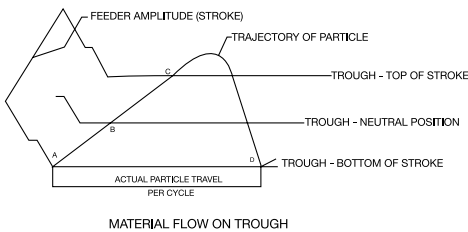

The diagram (above) illustrates the action of a single particle of material moving along the tray’s surface. During a vibrating stroke the tray surface travels between its lowest point “A” to its highest limit “C”. On the upward stroke, the particle is in contact with the tray from “A” to “B”. At that point the velocity of the particle become greater than the tray and the particle leaves the surface on a feed flight trajectory from “B” to “D”. The particle lands forward on the tray at point “D”. This completes one cycle.

With equipment operating on a 60-cycle power supply, this cycle of material flow is repeated 3600 times per minute. Adjusting or varying the stroke of the tray controls the feed rate. The number of strokes will remain constant to the power supply. However, the stroke length can be varied by changing the voltage input to increase or decrease the feed rate.

Each vibratory feeder or conveyor is designed with a different amplitude, frequency and angle of deflection in order to move different materials at specific rates. The equipment’s design is based on many factors including the material being processed, flow rate of the process, nature of the environment, need to start and stop (cycle) the process, cost to operate the equipment and likelihood of repairs. All of these considerations are covered in some detail.

#### **Did you know?**

*All feeders and conveyors don't impart the same G forces. The lower the force, the more gently the product is handled, resulting in less damage. For instance, Brand A's electromagnetic feeder operating at .100 in (2.54 mm) amplitude at 60Hz imparts 18.4 G's of energy into the product. Eriez' High Deflection Feeders operating at .187 in (4.75 mm) amplitude, but at a frequency of 30Hz only imparts 8.6 G's of force. By using greater amplitude and reducing the frequency, Eriez is able to accomplish the same flow rate while causing far less damage to the product!*



## Single-Mass & Two-Mass Designs

Feeders and conveyors transfer their drive's natural vibration to the tray either through a single mass or two mass system. The drive unit is contained in the "moving mass" and creates the vibratory motion. Single-mass units are anchored in position (usually to the floor) and transfer the drive's vibration directly to the tray or trough through its springs. By using the factory's floor as a reaction base, a single-mass conveyor can be destructive causing damage and creating vibration in the shop floor.

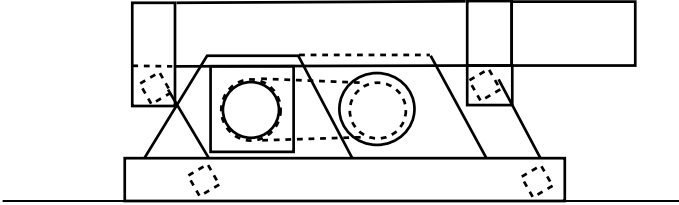

A Two-mass unit has the "moving mass" connected to the "reaction mass" by springs which drive the vibration in the tray. Two-mass conveyors and feeders have a natural frequency of vibration. Eriez' feeders have a natural frequency range of up to 70 cycles per second, versus line or operating frequency of 60 cycles making them "subresonant". Since the feeder is tuned near operating frequency, it takes advantage of the natural magnification of vibratory amplitude that occurs when a vibrating system is operating near its resonant condition. Thus, a relatively small force is amplified to generate the required vibratory motion.

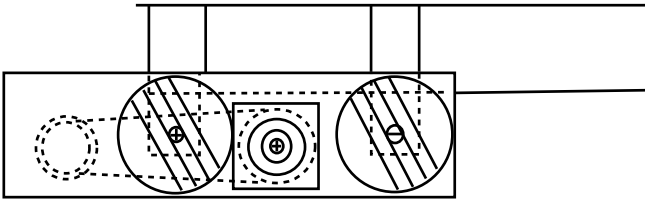

### **Did you know?**

*In order to move the same head load, a single-mass conveyor would require a 10 horsepower motor, where as a two-mass system would need only a two horsepower motor.*

## EQUIPMENT COMPONENTS

All vibratory equipment share common components... a drive system to generate the vibration, a tray or trough to carry the product and springs to give the vibration amplitude creating motion. Every system will require an AC or DC power source and must be mounted either from above or below in order to produce a consistent force.



### Drive Systems

In the mid 1950's, Eriez parlayed their considerable knowledge of magnetics and process engineering to develop a new-patented electromagnetic drive system. This new drive, named Hi-Vi, offered remarkable advantages over other systems available in the market. The Hi-Vi drive was the basis for Eriez' first feeder product line. Eriez now designs and builds a complete line of electromagnetic and mechanical vibratory units.

### Electromagnetic Drives

Electromagnetic drive systems operate by either AC or DC power. Both drives use magnetic circuits to energize the vibratory motion. A spring setup is mounted to a mass within or on the drive and attached to the unit's tray. Each of these drives has its advantages with AC units providing high precision with lower operating costs and the DC models typically being less expensive.

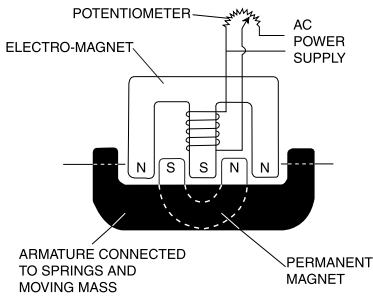

AC Operated Electromagnetic Drives using “alternating opposing and attracting magnetic forces” are extremely accurate, reliable and energy efficient. These units have no sliding or rotating parts to wear out and require very little power to operate. Eriez' patented AC operated electromagnetic drives incorporate a permanent magnet whose poles are intermeshed with those of an electromagnet powered directly by alternating current. This results in the spring-mounted moving mass being both attracted and repelled by the AC electromagnet equally on each half of the AC cycle. See the diagram A.



### Did you know?

*Eriez AC electromagnetic drives operate with such high efficiency they consume up to 65% less energy than typical DC drives! You can calculate your savings by going to [www.eriez.com](http://www.eriez.com).*

DC Operated Electromagnetic Drives are the most common type of electromagnetic drive and produce the same vibratory action as AC operated units. However, there are some disadvantages. These drives use a less efficient “attract and release” system where half of the sine wave is eliminated with a rectifier and turned into heat, and the DC pulsed power delivery is much less linear. This means as voltage is increased to the unit, power is squared. Alternatively, an AC operated drive using the full sine wave delivers power to the unit proportionately to the voltage increase... a “smooth” increase in power.

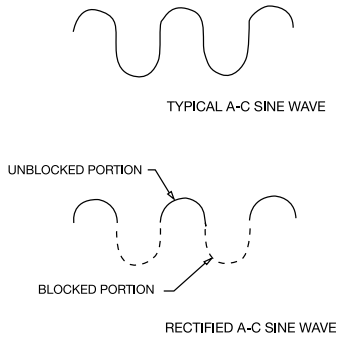

## Mechanical Drives

Mechanical vibratory drives come in a wide range of designs. These drives create a back and forth motion of a tray caused by either a direct mechanical linkage (push rod) or by a stimulating motion with out-of-balance weights then amplifying that vibration into the tray through a set of springs. The following are types of mechanical drives:

*Brute Force* mechanical drives use two special motors with eccentric weights on each end of a shaft that creates an out-of-balance vibration and motion into the tray. These are simple designs needing large motors to overcome the head load (weight of material) resting in the tray.

*Eccentric shaft* mechanical drives use a standard off-the-shelf motor driving an out-of-balance “eccentric” shaft. The eccentric shaft creates a small vibration that is amplified through a spring system. These units are considered two-mass systems that work to increase amplitude under the head load.

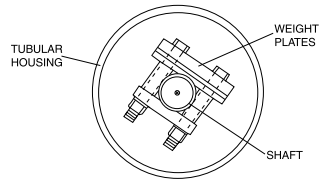

*Direct Drive* mechanical drives use a crank arm powered by a rotating motor that is attached directly to the feeder’s tray. These are less efficient, antiquated designs that require much larger motors and a lot of maintenance.

*Non-Vibratory, Eccentric Shaft* mechanical drives use a set of weights being powered by a motor that is alternately “in phase” and “out of phase” which creates a slow motion in one direction and a fast motion in the opposite direction. This action causes the tray to slide underneath the material. These units are ideal for fragile materials that can be damaged from the normal vibratory motion.



## Spring Systems

Springs are used to convert the vibration from the drive to tray thus causing product to move. Springs come in a variety of materials, sizes and configurations. From thin sheets of fiberglass to dense rubber compounds to thick steel coils... each material is designed for specific applications. In some applications, a combination of spring materials may be used.

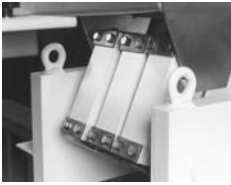

*Fiberglass Springs* (or boards) are the most popular spring configuration for light and medium duty applications. Fiberglass springs of varying lengths, widths and thickness are mounted on the moving mass of the drive and are attached to the tray or trough. Small electromagnetic feeders, light duty conveyors and most high precision vibratory equipment use fiberglass or multiple pieces of fiberglass as their primary spring action material.

*Dense Rubber Springs* are typically used on heavy-duty feeders and conveyors to provide stability and motion control between the drive and the tray. However, rubber springs are limited to use in environments below 120° F.

*Steel Coil Springs* are commonly used in heavy duty and high temperature applications. These coils are effective in ambient temperatures up to 300° F and offer low replacement cost.

### **Tray or Trough Designs**

In order to function properly, it's imperative the center of gravity of the tray be mounted slightly above the driveline of the motor. See diagram A (drive line). The drive line is generally the centerline of the motor's casting. Field alterations to the tray or trough will likely change this balance altering the performance of the feeder.

Selecting the proper tray (feeding) or trough (conveying) depends on the material being moved, distance traveled and the equipment's application. Trays and troughs are fabricated from mild steel and stainless steel. Stainless steel is used in food and pharmaceutical applications, while mild steel is for general-purpose use. Tray and troughs can be lined with abrasion resistant steel, stainless, polyethylene, epoxy, rubber as well as other coatings. The shape, length and width of the tray are almost limitless. Every configuration of flat, curved, v-channel, tubular designs are available.

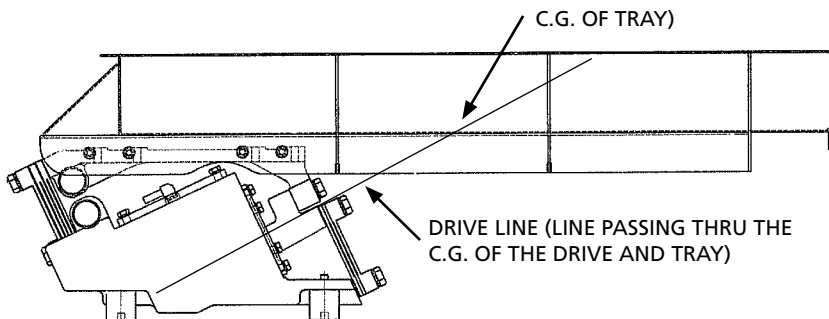



## MATERIAL AND PROCESS CONSIDERATIONS

There are many factors involved in choosing the proper vibratory feeder, conveyor or screener. The material being processed is the most important element in selecting equipment. Many standard models of feeders and conveyors can be fine tuned to improve the product flow. Selecting the proper equipment for the type of application can ensure years of trouble free service. Below are some of the key considerations.

### Material Considerations

#### Product Size

One of the most obvious considerations when selecting vibratory equipment is the size of the material to be processed.

##### *Fine Material*

Materials from -50 mesh to -400 mesh do not feed well on traditional Electromagnetic Feeders. They tend to fluidize and flush. The only way to handle them on vibratory feeders is to use a high deflection electromagnetic (3/16" (4.76 mm) amplitude x 30 Hz) feeder for low capacities or a mechanical (1/4 to 7/16" (6.35 to 11.11 mm) amplitude x 20 Hz) feeder for larger capacities.

##### *Midsized Material*

Materials ranging from +50 mesh to 2 - 3" (50.8 - 76.2 mm) in size feed very well on traditional Electromagnetic (.045 to .060" (1.143 to 1.524 mm) amplitude x 60 Hz) or Mechanical Feeders. An Electromagnetic Feeder will offer the most precise control and a Mechanical Feeder or high deflection Electromagnetic Feeder will offer the greatest capacity.

##### *Coarse Material*

Materials in the +2" to 12" (50.8 - 304.8 mm) range are best fed on mechanical feeders, especially at greater capacities due to the small amount of surface contact.



#### **Did you know?**

Eriez offers a Screen Chart to help determine the proper mesh screen to size product. This helpful tool can be downloaded at [www.eriez.com](http://www.eriez.com).

#### Product Moisture Content

Moisture may cause severe feeding problems especially on Electromagnetic Feeders, because moisture increases the surface tension and material tends to build up on the tray surface. At times, special textured surfaces or liner materials can be used to minimize this condition.

## Material Bulk Density

The weight or bulk density of a product effects its feeding characteristics greatly. Light (less than 10 lbs (4.53 Kg)/cubic feet) materials, especially fine (-50 mesh) do not have as much mass and feed more slowly than heavier products. High Deflection electromagnetic or mechanical feeders handle these light weight products effectively.



### **Did you know?**

*Eriez' FeederCap® software helps calculate feeder tray capacities. Input values from your process and then select your product's "Material Bulk Density" from FeederCap's comprehensive library and the program automatically recommends the best feeder for your application. Available online at [www.eriez.com](http://www.eriez.com).*

## Product Flexibility

Rigid or solid products feed better on an Electromagnetic Feeder. Products that are more flexible can be fed more successfully on high deflection Electromagnetic or Mechanical Feeders.

## Product Durability

Fragile materials are best fed or conveyed on a high deflection vibratory unit. These types of feeders produce substantial less "G force" than full cycle (60Hz) electromagnetic feeders. Less G force means less product damage.

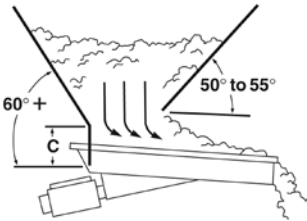

### **Feeder Head Loading**

Head load is the amount of material weight that is resting on a feeder. Some feeders are capable of handling more head load than others handle. If a feeder is being used under a hopper, it must be capable of starting and operating at full amplitude with the head load.

## Process Considerations

### **Cycling or Continuous Operation**

Different feeders are capable of being cycled (stopped and started) more often. Electromagnetic feeders are ideal for cycling applications and due to their design do not have the stress put on a belt or clutch when being cycled. These feeders have no belts, bearings or moving components to wear out.

### **Type and Length of Service**

Is the equipment expected to operate many years without service or is your application short term? The initial investment for a large Electromagnetic Feeder may be more, but it is efficient and does not require "normal" maintenance for 10-15 years. This may make it less expensive over the life of its use.

### Feeders, Electromagnetic

*Small A & C Model Feeders* – These are small electromagnetic vibratory feeders that operate at up to .60" (15.25 mm) amplitude at line frequency (either 50-60 Hz). They are commonly used under hoppers and can offer precise flow of dry granular products at capacities of up to 500 cubic feet (14.15 cubic meters)/hour of materials weighing up to 100 lbs (45.35 Kg)/cubic feet.



*High Speed Model Feeders* – The HS Feeder is a variation of the A and C models designed mainly for packaging and production applications requiring frequent on/off cycling (up to 100 times/minute). Being designed mainly for food packaging applications, they can operate at up to .090" (2.28 mm) amplitude at 50-60 cycles and feed up to 600 cubic feet (16.9 cubic meters)/hour of materials weighing 30-40 lbs (13.6-18.1Kg)/cubic feet.



*High Deflection Model Feeders* – These unique Electromagnetic Feeders operate at a higher (4.76 mm) amplitude and lower frequency (30 CPS) enabling them to handle hard-to-feed materials such as fine powders and flexible leafy products. The HD series can handle up to 19.82 cubic meters/hour of light products such as cereal weighing 4.53-6.8 Kg/cubic feet.



*B Feeders* – Eriez B Feeders are heavy duty Electromagnetic Feeders designed for the glass, steel, chemical, fastener, coal, and aggregate markets where high capacity is required with the best linearity. B Feeders are virtually maintenance free. They can be provided with abrasion resistant replaceable liners and with capacities of 400-1700 cubic feet (11.32 - 48.13 cubic meters)/hour.



## Feeders, Mechanical

*HV Feeders* – is a unique low profile two-mass rubber spring design using many standard off-the-shelf components. It is ideal for use in tunnels or in areas where headroom is a problem. HV Feeders have capacities of 2,000-40,000 cubic feet (56.63 to 1132.67 cubic meters)/hour of aggregates, glass, steel, and coal.



*Brute Force Feeders* – are single mass Mechanical Feeders powered by twin rotary motors. They are a very simple design and handle shock loading well, but lose power under heavy head loading. These units are very easy to repair, because you simply change the weighted motor.



## Conveyors

*VMC Conveyors* – is an Electromagnetic Conveyor that is virtually maintenance free (no belts or bearings) and has excellent linearity from 20% to 100%. Since it is electromagnetic, it is very good for cycling applications.



*SM Conveyors* - Single mass units are Eriez' least expensive mechanical conveyors, because they use the floor or base as their reaction mass. This allows for a low profile and efficient system to convey materials and parts. These efficient single mass conveyors move light loads of bulk materials at flow rates up to 18 tph (16mtp/h).

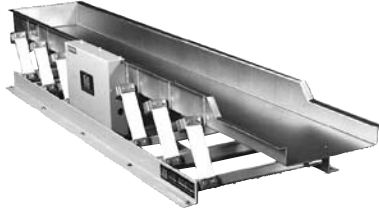

*TM Conveyors* – are two-mass Mechanical Conveyors designed for medium duty applications such as food and pharmaceutical. They use off-the-shelf motors, standard bearings and fiberglass springs.



*HV Conveyors* – is a heavy duty two-mass Mechanical Conveyor designed for coal, glass, and aggregate type applications. It can be supplied with replaceable AR liners. It uses a unique rubber spring that can be adjusted for the optimum drive angle.



*Horizontal Motion Conveyors* – The E-Z Slide™ Horizontal Motion Conveyor is ideal where gentle handling of self-cleaning is required such as in snack foods or processing of friable products. The unique drive causes the tray to move forward slowly carrying the product, then reverse rapidly, causing the tray to slide back quickly.



## **CUSTOM EQUIPMENT & APPLICATIONS**

Eriez operates the largest Test and Research facility of its kind for developing custom equipment to meet the most demanding applications. Contact a product manager to design the perfect vibratory solution for your specific needs.

**FOR MORE INFORMATION** on vibratory feeders, conveyors or any of the many other vibratory components and systems available for automation, material movement, separation, purification, benefication, reclamation and pollution control, write or call

### **ERIEZ MAGNETICS WORLD HEADQUARTERS**

2200 Asbury Road, P.O. Box 10608, Erie, Pennsylvania 16514, U.S.A.  
800/345-4946 or 814/835-6000

Plate Magnets  
Grate Magnets  
Ferrous Traps  
Magnetic Humps  
Suspended Magnets  
Magnetic Pulleys  
Magnetic Sweepers  
Dry Magnetic Drums  
Wet Magnetic Drums  
High Intensity Separators  
Electrostatic Separators  
Superconducting HGMS  
Rare Earth Magnetic Roll Separators  
Magnetic Flocculators  
Demagnetizing Coils  
Metal Detectors

Eddy Current Separators  
Magnetic Rails  
Magnetic Rolls  
Sheet Fanners  
Lifting Magnets  
Holding Magnets  
Coolant Cleaners  
Magnetic Conveyors  
Vibrating Conveyors  
Mechanical Conveyors  
Vibratory Feeders  
Volumatic Feeders  
Bin Vibrators  
Precipitator Vibrators  
Screen Separators

### **NOTES:**

***For solutions to  
your process problems  
contact your nearest  
Eriez representative  
and just: Ask Orange.***



## **CONTACT ERIEZ**

With manufacturing plants on five continents and a global network of factory-trained representatives, getting professional assistance is just a call away.

<b>Country Code:</b>	<b>Telephone:</b>	<b>E-mail:</b>
<b>AUSTRALIA</b> .....61.....	3-9305-4099 .....	eriezaus@eriez.com.au
<b>CANADA</b> .....01.....	905-795-0444 .....	eriezcanada@eriez.ca
<b>CHINA</b> .....86.....	21-5046-2123 .....	eriez@eriez.com.cn
<b>EUROPE</b> .....44.....	29-208-68501 .....	eriez@eriezeurope.co.uk
<b>INDIA</b> .....91.....	80-845-5381 .....	emil@emil.co.in
<b>JAPAN</b> .....81.....	473-546381 .....	thomma@eriez.co.jp
<b>MEXICO</b> .....52.....	5-565-3855.....	operaciones@avante.net
<b>SOUTH AFRICA</b> .....27.....	11-444-9160 .....	eriezmag@iafrica.com
<b>UNITED STATES</b> .....01.....	814-835-6000.....	eriez@eriez.com



©2007 ERIEZ MAGNETICS ALL RIGHTS RESERVED



*World authority in advanced technology for magnetic,  
vibratory and inspection applications*

Eriez manufactures magnetic lift and separation, metal detection, materials feeding, screening, conveying and controlling equipment for application in the process, metal working, packaging, recycling, mining, aggregate and textile industries among others. Eriez manufactures and markets these products through nine international facilities located on five continents... Australia, Brazil, Canada, China, England, India, Japan, Mexico, South Africa, as well as the United States.

Some safety warning labels or guarding may have been removed before photographing this equipment.

0707-5M-SBC-MC